

**CDG**  
**Your Professional Guide to**  
**Office | Home | School**  
**Wellness and Ergonomic Care**



<https://www.cdgreat-officefurniture.com/>

No, 526, Section 1, Shenlin Road, Daya District,  
Taichung City Taiwan 42865

+886-4-25679181

cd.great@msa.hinet.net

Find us on   

20 years of OEM & ODM furniture  
manufacturer from Taiwan. Specialize  
in metal parts, goods and end  
products.

 **CD Great Industry Co, Ltd**



# Company profile

C.D. Great Industry Co., Ltd. was founded in 2002 with a priority on high-quality ergonomic products that improve people's wellness, comfort and productivity. We have experience, capability, and R&D resources to develop and manufacture OEM and ODM products. We also provide comprehensive solutions for clients to refine the design, streamline manufacturing process to reduce costs, making designs possible for manufacturing and appropriate for marketing.

Our products are manufactured under a strict control program with ISO9001 certified. In order to meet each customer's expectation, every step of the manufacturing process is monitored under supervision including incoming material inspection, processing and product inspection, final-product inspection, packaging regular check-ups so that quality and safety standard is guaranteed. Our mission is to provide high-quality products and efficient service with the most innovative designs and attractive prices to our worldwide customers.

## Introduction to OEM Capability

### OEM/ODM Service

CDG is a professional OEM/ODM service provider, we own years of experience in design and manufacturing.

We offer ergonomic design and verification services for creating a series of innovative products. Cost effective and quality products are what we are concerned for our clients. With quality control laboratory and production management ability, we can be your reliable partner.



ESTABLISHED IN 2002

#### R&D Capability

- Customized product design
- Prototype development and verification
- Product packaging design



BASED IN TAIWAN

#### Manufacturing Capability

- 600 containers shipped a year
- Good quality assured in mechanical structure
- Assembly ability for easy installation to end users



QUALITY ASSURED

#### Quality Control

- Various Inspection Equipments for different testing, including Projection comparator, RoHS Analyzer, fatigue, hardness and endurance capability testers to ensure the best quality provided
- Strict quality inspection for incoming material and finished goods
- Quality assurance is maintained at each step of production
- Products are manufactured under a strict control program with ISO 9001 certified



*Professional in OEM&ODM service, located in Taiwan.*

*Specialize in metal parts, goods and end products.*





*Corrosion*



*Product Inspection Weight Check*



*Cycle Testing Machine 3*



*RoHS Tester*

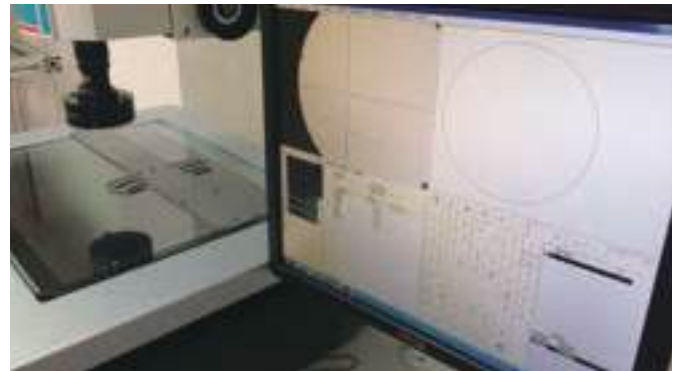

## 3D Printer



*Horizontal Measurement Instrument*

**Dia. 300mm / Dia. 600mm**

Certificate TW10/00310

The management system of

## C.D. Great Furniture Co., Ltd.

No. 526, Sec. 1, Shen Lin Rd., Da Ya Dist., Taichung City 428, Taiwan R.O.C.

has been assessed and certified as meeting the requirements of  
**ISO 9001:2015**

For the following activities

Design, Assembling and Sale of TV Stand, TV Mounting Bracket and Furniture.



This certificate is valid from 28 June 2022 until 28 June 2025 and remains valid subject to satisfactory surveillance audits.

Issue 6, Certified since 28 June 2010.

Authorised by

SGS United Kingdom Ltd

Rossmore Business Park, Ellesmere Port, Cheshire, CH65 3EN, UK  
t +44 (0)151 350-6666 - [www.sgs.com](http://www.sgs.com)



This document is issued by the Company subject to its General Conditions of Certification Services accessible at [www.sgs.com/terms\\_and\\_conditions.htm](http://www.sgs.com/terms_and_conditions.htm). Attention is drawn to the limitations of liability, indemnification and jurisdictional issues established therein. The authenticity of this document may be verified at <http://www.sgs.com/en/certified-clients-and-products/certified-client-directory>. Any unauthorized alteration, forgery or falsification of the content or appearance of this document is unlawful and offenders may be prosecuted to the fullest extent of the law.





## ED02 2-leg Height Adjustable Desking Frame

Weight Capacity	Up to 220 lbs / 100 kgs
Worktop fitting sizes	42- to 72-inch wide
Table width	34" / 863 mm to 64" / 1625 mm
Height Adjustable Range	660 mm (Stepless)
Height	595 mm to 1255 mm
Speed	30 mm / per second
Frame	Steel



## SP401 CPU PC Holder

Head Connecting Piece Swivel	360°
Material	Aluminum
Weight Capacity	22 lbs/ 10 kgs
Width	90-240 mm
Height	365-565 mm



## Height Adjustable Table

CDG's electric height adjustable desk frame series come with a sleek and sturdy structure which is height adjustable, width expandable and durable. We offer a desking solution for hassle-free setup with lifting technology incorporated and movement controlled by an easy fingertip touch. With the smart control Memory Function, it is remarkably easy to switch between sitting and standing or any preferable height without interrupting workflow. Simply just pick a desktop and you are all set to go!



### ED03 3-leg Height Adjustable Desking Frame

Weight Capacity	Up to 330 lbs / 150 kgs
Table Frame Opening Closure	90° OR 120°
Width	50.2" / 1275 mm to 80.2" / 2037 mm
Height Adjustable Range	660 mm (Stepless)
Height (Table leg)	23.4" / 595 mm to 49.4" / 1255 mm
Speed	30 mm / per second
Desk Frame	Steel

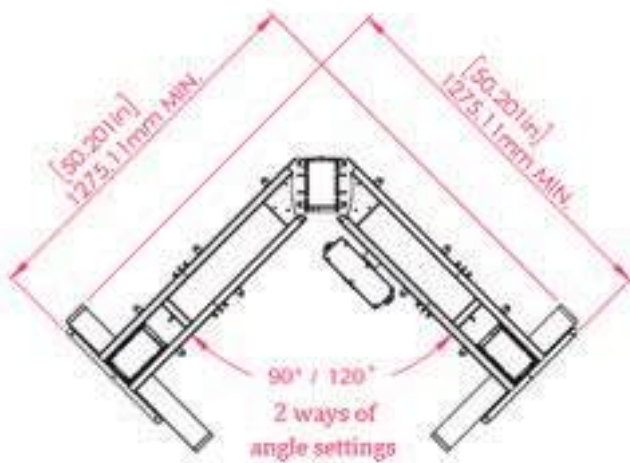



### OL001 Sit-Standing, Height Adjustable, Fliptop and Folding Big Table Desk

Material	MDF+ Melamine Laminate
Desktop Dimension	1,500mm X 700mm
Desktop Thickness	18mm
Height	75cm~105cm(±1cm)
Color	White
Base Height	132mm
Base Material	Iron, Plastic, Rubber
Caster Size	2"
Weight Capacity	50kg
Column Material	Aluminum, Iron, POM
Total Weight	48kg



### OL002 Mobile Height Adjustable Table with Drawer on Wheels for Student, School and Office Use

Desktop Material	MDF+ Melamine Laminate
Desktop Dimension	700mm X 500mm
Desktop Thickness	18mm
Height	74cm ~ 117cm(±1cm)
Color	White
Base Height	143mm
Base Material	Iron, Plastic, Rubber
Caster Size	2"
Weight Capacity	50kg
Column Material	Aluminum, Iron, POM
Total Weight	19.22kg





### HC101 Mobile Height Adjustable Electric Laptop Table Desk on Wheels

Desktop Material	MDF + Melamine Laminate
Desktop Dimension	600mm X 400mm
Desktop Thickness	18mm
Height	67.6 cm ~ 107.6 cm(±1cm)
Color	White
Base Height	53mm
Base Material	Iron& ABS
Caster Size	2"
Weight Capacity	20kg
Column Material	Aluminum, Iron& POM
Lifting Speed	28.8mm/sec
Total Weight	14.9kg



### HC103 Mobile Height Adjustable Electric Laptop Table Desk with Keyboard Tray on Wheels

Desktop Material	MDF + Melamine Laminate
Desktop Dimension	110cm X 60cm
Desktop Thickness	18mm
Keyboard Dimension	630mm x 240mm
Keyboard Thickness	15mm
Height	73cm ~ 118cm(±1cm)
Color	White
Base Height	68mm
Base Material	Iron, Plastic
Weight Capacity	50kg
Column Material	Aluminum, Iron, POM
Total Weight	28.8kg





## HC104 Electric Sit-Standing Corner Table & Keyboard Tray(Optional)

Desktop Material	MDF+ Melamine Laminate
Desktop Dimension	110cm X 60cm
Desktop Thickness	18mm
Keyboard Dimension	630mm x 240mm
Keyboard Thickness	15mm
Height	73cm ~ 118cm (±1cm)
Color	Wooden+ White
Base Height	68mm
Material	Iron, Plastic, Aluminum, Iron, POM
Weight Capacity	50kg
Total Weight	23.36kg



## HC105 Electric Height Adjustable Table & Keyboard Tray(Optional)

Desktop Material	MDF+ Melamine Laminate
Desktop Dimension	110cm X 60cm
Desktop Thickness	18mm
Keyboard Dimension	630mm x 240mm
Keyboard Thickness	15mm
Height	73cm ~ 118cm (±1cm)
Color	Wooden+ White
Base Height	35mm
Material	Wooden Board+ Plastic+Iron, Aluminum, Iron, POM
Weight Capacity	50kg
Total Weight	25kg



## HC106 Electric Height Adjustable Corner Table & Keyboard Tray(Optional)

Desktop Material	MDF + Melamine Laminate
Desktop Dimension	110cm x 60cm
Desktop Thickness	18mm
Keyboard Dimension	630mm x 240mm
Keyboard Thickness	15mm
Height	73cm ~ 118cm (±1cm)
Color	Wooden + White
Base Height	35mm
Material	Wooden Board+ Plastic+ Iron, Aluminum, Iron, POM
Weight Capacity	50kg
Total Weight	22kg



## HC107 Pneumatic Height Adjustable Table & Keyboard Tray(Optional)

Desktop Material	MDF + Melamine Laminate
Desktop Dimension	110cm x 60cm
Desktop Thickness	18mm
Keyboard Dimension	630mm x 240mm
Keyboard Thickness	15mm
Height	75cm ~ 118cm (±1cm)
Color	Wooden + White
Base Height	35mm
Material	Wooden Board+ Plastic+ Iron, Aluminum, Iron, POM
Weight Capacity	50kg
Total Weight	26kg



## HC108 Pneumatic Sit-Standing Corner Table & Keyboard Tray(Optional)

Desktop Material	MDF + Melamine Laminate
Desktop Dimension	110cm x 60cm
Desktop Thickness	18mm
Keyboard Dimension	630mm x 240mm
Keyboard Thickness	15mm
Height	75cm ~ 118cm (±1cm)
Color	Wooden + White
Base Height	35mm
Material	Wooden Board+ Plastic+ Iron, Aluminum, Iron, POM
Weight Capacity	50kg
Total Weight	24kg





### SP902 Rolling Standing Desk w/ Large Desktop and Locking Wheels

Desktop Material	MDF (Medium Density Fiberboard) w/NC printing
Desktop Dimension	60 (w) x 40 (d) cm
Desktop Thickness	18 mm
Tilt	+/- 45°
Height Range	30" - 46" (76 - 116 cm)
Height Adjustment	+/- 16" (40 cm)
Weight	10 kgs
Weight Capacity	8 - 10 kgs
Base Material	Iron
Optional Color	 Black White Silver



### SP903 Rolling Standing Desk w/ Large Desktop

Desktop Material	MDF (Medium Density Fiberboard) w/NC printing
Desktop Dimension	60 (w) x 40 (d) cm
Desktop Thickness	18 mm
Tilt	+/- 45°
Height Range	29" - 42" (73 - 107 cm)
Height Adjustment - Tension Sprintg	+/- 13" (34 cm)
Weight	9 kgs
Weight Capacity	8 - 10 kgs
Base Material	Iron
Optional Color	 Black White Silver



### SP901-A Mobile Laptop Desk with Side Table

Platform Material	Iron
Desktop Dimension	Dimension: 52.5 (w) x 30 (d) cm Small tray: 17 (w) x 30 (d) cm Large tray: 35 (w) x 30 (d) cm
Platform Thickness	1.5 mm
Tilt	+/- 45°
Height Range	24.5" - 38" (62 - 96 cm)
Manual Height Adjustment	+/- 34 cm
Weight	9 kgs
Weight Capacity	8-10 kgs
Base Material	Metal cover and iron plate
Optional Color	 Black White Silver



### SP905 Height Adjustable Rolling Laptop Cart Bed Side Table

Desktop Material	MDF (Medium Density Fiberboard) w/NC printing
Desktop Dimension	Dimension: 52.3 (w) x 30 (d)cm Small tray: 17 (w) x 30 (d) cm Large tray: 35 (w) x 30 (d) cm
Desktop Thickness	12 mm
Tilt	+/- 45°
Height Range	27.5" - 41" (70 - 104 cm)
Height Adjustment - Tension Sprintg	+/- 13.5" (34 cm)
Weight	8 kgs
Weight Capacity	8 - 10 kgs
Base Material	Iron
Optional Color:	 Black White Silver



### SP901-B Mobile Laptop Desk with Side Table

Platform Material	MDF (Medium Density Fiberboard) w/NC printing
Platform Dimension	Dimension: 52.5 (w) x 30 (d) cm Small tray: 17 (w) x 30 (d) cm Large tray: 35 (w) x 30 (d) cm
Platform Thickness	12 mm
Tilt	+/-45°
Height Range	24.5" - 38" (62 - 96 cm)
Manual Height Adjustment	+/- 34 cm
Weight	6 kgs
Weight Capacity	8 - 10 kgs
Base Material	Plastic cover and iron plate
Optional Color:	 Black White Silver





**SP901-C Mobile Laptop Desk with Side Table**

Platform Material	Glass
Platform Dimension	Dimension: 52.5 (w) x 30 (d) cm Small tray: 17 (w) x 30 (d) cm Large tray: 35 (w) x 30 (d) cm
Platform Thickness	5 mm
Tilt	+/- 45°
Height Range	24.5" - 38" (62 - 96 cm)
Manual Height Adjustment	+/- 34 cm
Weight	6.5 kgs
Weight Capacity	8 - 10 kgs
Base Material	Glass (10mm thickness)
Optional Color	  Black White



**SP901-D Mobile Laptop Desk with Side Table**

Platform Material	Iron
Platform Dimension	Dimension: 52.5 (w) x 30 (d) cm Small tray: 15 (w) x 30 (d) cm Large tray: 35 (w) x 30 (d) cm
Platform Thickness	1.5 mm
Tilt	+/- 45°
Height Range	26" - 39" (65.5 - 98.5 cm)
Manual Height Adjustment	+/- 34 cm
Weight	5 kgs
Weight Capacity	8 - 10 kgs
Base Material	Iron
Optional Color	   Black White Silver



**SP908 Rolling Laptop Desk with Storage Area**

Desktop Material	MDF (Medium Density Fiberboard) w/PVC
Desktop Dimension	Origin: 60 x 32 cm Extended: 80 x 32 cm
Desktop Thickness	15 mm
Height Range	30" - 35" (76 - 90 cm)
Height Adjustment	+/- 5.5" (14 cm)
Weight	11 kgs
Weight Capacity	8 - 10 kgs
Base Material	MDF (Medium Density Fiberboard) w/PVC



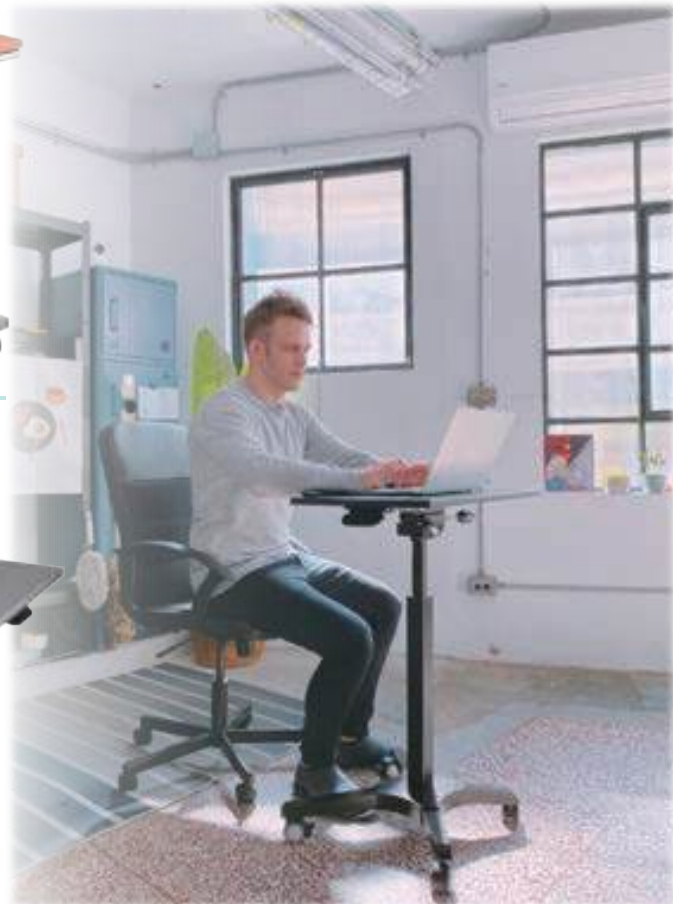

**SP909 Rolling Laptop Desk with Magazine Bag**

Desktop Material	MDF (Medium Density Fiberboard) w/PVC
Desktop Dimension	Origin: 52 x 30 cm Extended: 67 x 30 cm
Desktop Thickness	15 mm
Height Range	24" - 36" (61 - 91 cm)
Height Adjustment	+/- 12" (30 cm)
Weight	7 kgs
Weight Capacity	8 - 10 kgs
Base Material	MDF & Iron Tube



**Portable Laptop Desk**

**SP906 Sit-Stand Desk w/ Large Desktop**

Desktop Material	MDF (Medium Density Fiberboard) w/NC printing
Desktop Dimension	60 (w) x 40 (d) cm
Desktop Thickness	18mm
Height Range	24"-38" (62-96cm)
Height Adjustment	+/- 34 cm
Weight	8.5 kgs
Weight Capacity	8-10 kgs
Base Material	Iron
Optional Color	   Blac Whit Silver



**SD101 Student Desk Training Table (Bent feet)**

Desktop Material	Melamine Faced MDF Board
Desktop Dimension	793 mm X 537 mm
Desktop Thickness	25 mm
Height	75 cm (±0.5 cm)
Color	Wood / White or Custom Color
Wheels	2" PU Wheel
Weight Capacity	140 kgs
Desk Frame Material	Steel
Drawer Dimension	364 mm X 270 mm X 106 mm
Total Weight	17.1 kgs



**SD102 Student Desk Training Table (Beveled feet)**

Desktop Material	Melamine Faced MDF Board
Desktop Dimension	793 mm X 537 mm
Desktop Thickness	25 mm
Height	75 cm (±0.5 cm)
Color	Wood / White or Custom Color
Wheels	2" PU Wheel
Weight Capacity	140 kgs
Basement Height	139 mm
Desk Frame Material	Steel
Drawer Dimension	364 mm X 270 mm X 106 mm
Total Weight	14.3 kgs



**SD103 Foldable Training Table (Bent feet)**

Desktop Material	Melamine Faced MDF Board
Desktop Dimension	1200 mm x 500 mm
Desktop Thickness	25 mm
Height	75 cm (±0.5 cm)
Color	Wood / White or Custom Color
Desk Frame Material	Steel
Wheels	2" PU Wheel
Weight Capacity	140 kgs
Drawer Dimension	744 mm X 270 mm X 106 mm
Total Weight	26.3 kgs



**SD104 Flip Top Table (Beveled feet)**

Desktop Material	Melamine Faced MDF Board
Desktop Dimension	1200 mm x 500 mm
Desktop Thickness	25 mm
Height	75 cm (±0.5 cm)
Color	Wood / White or Custom Color
Basement Height	139mm
Desk Frame Material	Steel, rubber
Wheels	2" PU Wheel
Weight Capacity	140 kgs
Drawer Dimension	744 mm X 270 mm X 106 mm
Total Weight	22.3 kgs





**SP501** Vertebra Cable Management, Desk Cable Management, Cable Concealer

Application	Any tabletops or worktops allow screw fastening.
Capacity	Hollow space is available and accessible from both sides for numerous wires storage even with single organizer.
Length	1.5m (Length can be customized on request and subject to MOQ.)
Weight	1 kg
Optional Color	Black, White

**SP101** Classic Sit-Stand Height Adjustable Standing Desk Converter

Load Capacity	10~30 lbs / 4.5-13.6 kgs
Depth	600 mm / 23.62"
Minimum Height (when folded)	145 mm / 5.71"
Maximum Height (elevated to the full)	490 mm / 19.29"
Tabletop	MDF with Polyurethane Coating
Desk Frame	Steel SPHC PO
Cap	ABS Plastic
Optional Color	Black, White, Wood



**SP201 Premium / 2-tier Sit-Stand Workstation with Single or Dual Monitors Arm Set**

Monitor Compatibility	(S) up to 32"; (D) up to 27" per monitor
Monitor Capacity	(S) (D) up to 17 lbs / 8 kgs
Total Payload Capacity	(S) (D) up to 27 lbs / 12.2 kgs
Product Lifting Range	480 mm / 18.9"
Individual Monitor Lifting Range	200 mm / 7.8"
Height (from desktop to Top Worksurface)	120 mm / 4.7" to 620 mm / 24.4"
Individual Monitor Rotation / Tilt	(S) (D) 360° / (S) (D) ±20°
Desktop Thickness	20-90 mm / 0.7"-3.5"
Top Worksurface Dimension	305 mm D x 570 mm W (12" x 22.4")
Retractable Keyboard Platform Dimension	240 mm D x 630 mm W (9.4" x 24.8")
Material	PU Coat on MDF, polished, Aluminum, Iron parts

**SP203 Classic / 2-tier Sit-Stand Workstation with Single or Dual Monitors Arm Set**

Monitor Compatibility	(S) up to 32"; (D) up to 27" per monitor
Monitor Capacity	(S) (D) up to 17 lbs / 8 kgs
Total Payload Capacity	(S) (D) up to 27 lbs / 12.2 kgs
Product Lifting Range	480 mm / 18.9"
Individual Monitor Lifting Range	220 mm / 8.7"
Individual Monitor Rotation / Tilt	(S) (D) 360° / (S) (D) ±20°
Desktop Thickness	20-90 mm / 0.7"-3.5"
Top Worksurface Dimension	305 mm D x 570 mm W (12" x 22.4")
Retractable Keyboard Platform Dimension	240 mm D x 630 mm W (9.4" x 24.8")
Material	PVC finish on MDF, Iron parts

**SP201A Premium 1 Top / 1-tier Sit-Stand Workstation with Single or Dual Monitors Arm Set**



SP201

**SP203A Classic 1 Top / 1-tier Sit-Stand Workstation with Single or Dual Monitors Arm Set**



SP201A



SP203



SP203A



Single Monitor



Dual Monitor

Optional Color



Black





White



Silver



**SP204** Articulating Desk Mount Laptop Arm Workstation for Large Laptops (≤17")

Compatibility	Supports any Laptops no larger than 17"
Capacity	2.5-9.0 kgs (5.5-19.8 lbs)
Height Range	450 mm (17.7")
Platform Swivel	180°
Upper Arm Pivot	180°
Desktop Thickness	20-90 mm (0.7"-3.5")
Optional Color	  Black Silver



**PC801** Articulating Desk Mount Laptop Arm Workstation for Small or Lightweight Laptops

Compatibility	Supports 11"-14" Laptops
Capacity	1.0-3.5 kgs (2.2-7.7 lbs)
Height Range	285 mm (11.2")
Platform Swivel	100°
Upper Arm Pivot	360°
Lower Arm Pivot	360°
Desktop Thickness	5-55 mm (0.2"-2.2")
Color	Silver



**SP207E** Electric Sit-Stand Workstation with Dual Monitors Arm Set & Keyboard Tray



**Sufficient working space**

The standing monitor arm equipped with a large keyboard tray 25" x 9" / 630 x 240 mm. With the single flattened worktop, it's designed to offer laptop users with sufficient level space to easily accommodate laptops in various sizes or other work gear.

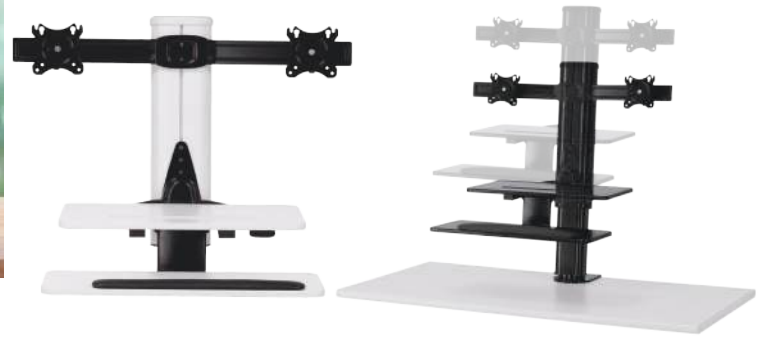

**SP208E** Electric Sit-Stand Workstation with Dual Monitors Arm Set & Keyboard Tray and Clamp Base Design

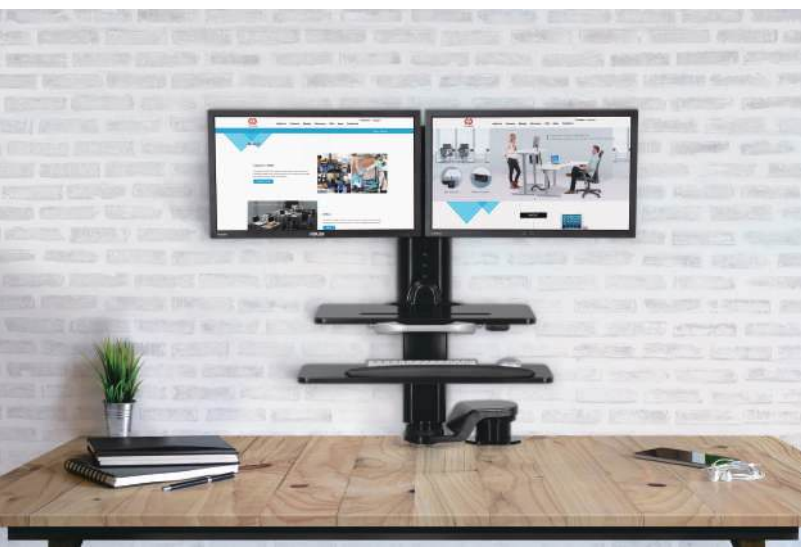



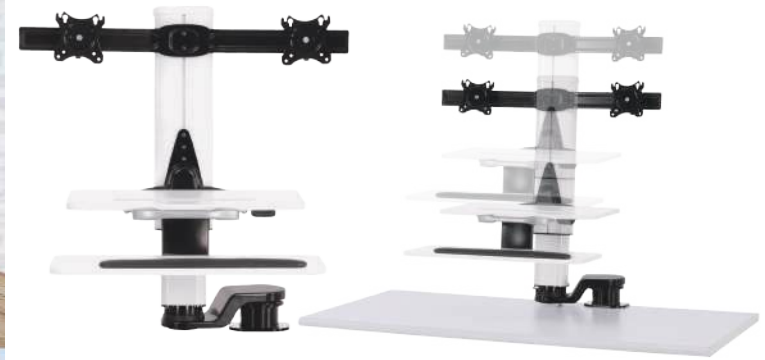

This electric sit stand monitor arm convert traditional office desk into an active workstation. The standing desk arm features a keyboard tray and easy, smooth, all around height adjustment that allows users to arrange workstation up or down, left or right to meet your needs.





## Height Adjustable Monitor Desk Clamp Set

Monitor Adaptation	 <p style="text-align: center;">Single</p>		 <p style="text-align: center;">Dual</p>	
code	SP601-SG	SP601-DG	SP601-S	SP601a-D
Color Variety				
	<input type="checkbox"/> Gray	<input type="checkbox"/> White	<input type="checkbox"/> White	<input type="checkbox"/> Gray
Monitor Capability	up to 32"		up to 27" per monitor	
Monitor Rotation	360°		360°	
Tilt	+45°~-45°		+25°~-25°	
Extra Adjustment for Dual Monitor Adaptation ONLY			Arm Axis 170° on either side Adjustable Viewing Distance +250 mm - -240 mm on either side	
Base	desk clamp			
Worktop Thickness	10-90 mm (0.4"-3.54")			
Base Column Dimension	120 mm W x 570 mm H x 35-50 mm D			
Minimum Height (from desktop)	230 mm (9")			
Maximum Height (from desktop)	430 mm (16.9")			
Height Adjustability Control	concealed crank			
Material	Aluminum			
Base options	Clamp or Grommet			





CDG's PC3 series offer sturdy and robust supports for single, dual, 3 or 4 monitors to cater for different users in various settings, including Home, Office, Laboratory, Control Center, Entertainment, Healthcare to name but a few. For applications on diversified flattened tops as well as different locations, mounting bases are available in wall mount, desk clamp or grommet styles.

CDG also advances its collection ranging from single monitor application to multiple-monitor display which suffices for heavy-duty adaptation. Standard color choices are available and can be customizable subject to the quantities. Possible and also available for mounting for more than 4 monitors.

### Articulating Wall mount for single monitor

Screen Compatibility	Suits the monitor $\leq 27"$
Vesa	75x75 mm to 100x100 mm
Capacity	3.8-8.1 kgs/ 8.4-17.8 lbs
Tilt	UP 90°; Down 45°
Pan	180°
Rotation	360°



PC301 Wall Monitor Mount



PC331 Curve Wall Monitor Mount

## LCD Monitor Mounts –PC3 series

### Articulating desk mount for single / multiple monitors

Screen Compatibility	Suits the monitor $\leq 27"$ (PC311, PC312) Suits the monitor $\leq 27"$ (PC313, PC314)
Vesa	75x75 mm to 100x100 mm
Capacity	3.8-8.1 kgs / 8.4-17.8 lbs
Tilt	UP 90°; Down 45°
Pan	180°
Rotation	360°
Base options	Clamp or Grommet
Optional Color	 Silver White AppleRed MetalGray SparkSilver



PC311 Desk Monitor Mount



PC312 Desk Dual-Monitor Mount



PC313 Desk Triple-Monitor Mount



PC314 Desk Quad-Monitor Mount

## Articulating Wall mount for single monitor

Mechanism	Gas Spring
Screen Compatibility	Suits the monitor $\leq 24"$
Vesa	75x75 mm to 100x100 mm
Weight Capacity (EA)	2-7 kgs / 4.4-15.4lbs
Tilt	UP 90°; Down 45°
Pan	180°
Rotation	360°
Arm Type	A=Arm Stem B=Adjustable Flexy Arm C=Extended Adjustable Arm
Surface treatment	Polish or Coating

### PC702-W Series Gas Spring Wall Monitor Mount



PC702-W-01-A



PC702-W-01-B



PC702-W-01-C

### PC702-S Series Gas Spring Wandklem Monitor Mount



PC702-S-01-A



PC702-S-01-B



PC702-S-01-C

## Dual Fully Adjustable Gas-Assisted Desk Mounts

### PC702-DC-02-C-L Dual Fully Adjustable Gas-Assisted Desk Mounts for 1 LCD Screen up to 27 inches and 1 Laptop Holder

Compatibility	Supports any Laptops no larger than 17"
Capacity	2.5-9.0 kgs (5.5-19.8 lbs)
Height Range	450 mm (17.7")
Platform Swivel	180°
Upper Arm Pivot	180°
Desktop Thickness	20-90 mm (0.7"-3.5")





# LCD Monitor Mounts –PC702 series

## Articulating desk mount for single / multiple monitors

Mechanism	Gas Spring
Screen Compatibility	Suits the monitor $\leq 24"$
Vesa	75x75 mm to 100x100 mm
Weight Capacity (EA)	2-7 kgs / 4.4-15.4lbs
Tilt	UP 90°; Down 45°
Pan	180°
Rotation	360°
Arm Type	A=Arm Stem B=Adjustable Flexy Arm C=Extended Adjustable Arm
Surface treatment	Polish or Coating
Base options	Clamp or Grommet / Heavy load



### PC702-DC, DG SERIES Single Gas Spring CLAMP Monitor Mount



PC702-DC-01-A



PC702-DC-01-B



PC702-DC-01-C

### PC702-DC,DG-02 Dual Gas Spring CLAMP Monitor Mount



PC702-DC-02-A



PC702-DC-02-B



PC702-DC-02-C

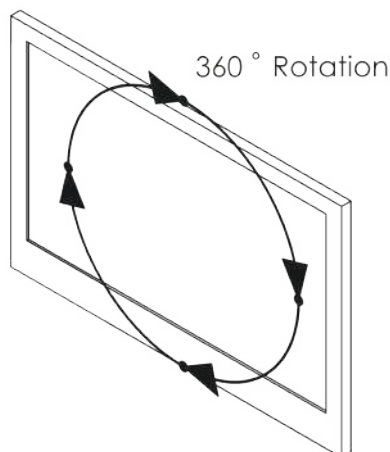
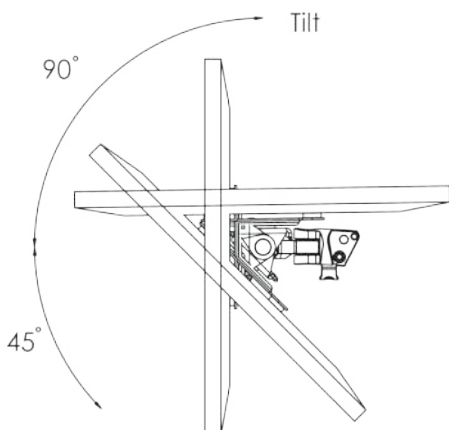

- 1 Support makes 4-direction installation possible.
- 1 mount base gives multiple supports so as to freely arrange monitor settings as desired.

## PC702-DC,DG-03 Triple Gas Spring CLAMP Monitor Mount



PC702-DC-03-B



PC702-DC-03-C

## PC702-DC,DG-04 QUAD Gas Spring CLAMP Monitor Mount



PC702-DC-04-C-H

## PC702-DC,DG-06 Six Gas Spring GROMMET Monitor Mount



PC702-DC-06-A+C-H

Screen Compatibility	Suits the monitor $\leq 24"$ for 3 to six monitors
Vesa	75x75 mm, 100x100 mm
Monitor Capacity	2-7.0 kgs/ 4.4-15.4 lbs
Tilt	UP 90°; Down 45°
IPan	180°
Rotation	360°
Worktop Thickness	Standard Base: 5-55 mm / 0.2"-2.1" Heavy Load Base: 18-90 mm / 0.7"-3.5"
Base Options	Standard (1-2 screens) Heavy Load (3-6 Screens)
Arm Option	A-Arm stem B-Adjustable Flexy Arm C-Extended Adjustable Arm
Material	Aluminum articulating arm & pole, Iron Base with Plastic Cover
Surface treatment	Polish or Coating





# Mobile Phone Stand & Tablet Holder

## IPKD-U 3-in-1 Foldable Tablet Tablet Stand Holder Mount

Compatible Model	Mobile Phone, iPad, Tab, Kindle and other tablet size of 4.7"-13"
Variety	Fits any mobile devices, phone, tablet size of 4.7"-13"
Tilt	Upwards 85°; Downwards 84°
Pan	180°
Screen Rotation	360°
Articulating Arm Swivel	360°
Screen Rotation	360°
Weight	550g



## IPSR-U Articulating floor tall stand for tablet

Compatible Model	Mobile Phone, iPad, Tab, Kindle and other tablet size of 4.7"-13"
Compatibility	Fits any mobile devices, phone, tablet size of 4.7"-13" by any maker
Variety	Choose iPS-U for the standard weighted base. Choose IPSR-U for the rectangle-shaped weighted base.
Tilt	Upwards 85°; Downwards 84°
Pan	180°
Screen Rotation	360°
Articulating Arm Swivel	360°





## Mobile medical tablet rolling cart

### AS-101 Lightweight mobile medical tablet rolling cart with basket

Compatible Models	Mobile Phone, iPad, Tab, Kindle and other tablet size of 4.7"-13"
Height	86.5cm~121cm(±1cm)
Base Material	Iron
Wheel Dimension	3inch
Weight Capacity for Basket	4kg
Tube Material	Iron
Basket Dimension	290x119x168mm
Total weight	5kg
Tilt	Upwards 85°; Downwards 84°
Screen Rotation	360°
Compatibility	Fits any mobile devices, phone, tablet size of 4.7"-13" by any maker



CDG can customize OEM parts for your need of home/office/desk and monitor mount products which is easy to get a solution even on a tough deadline whatever your industry or ergonomic field request.

## Monitor Mount Accessories



**PC311 Arm**  
Arm for PC311



**PC301 Arm**  
Arm for PC301



**PC321 i-Mac Arm**  
Arm for PC321 i-Mac



**PC702 Arm**  
Arm for PC702



**PC311-VP**  
PC311 VESA Plate



**203-S-VESA-Plate**  
SP203-S VESA Plate



**PC321 i-Mac VESA Plate**  
PC321 i-Mac VESA Plate



**203-D-VESA-Plate**  
SP203-D VESA Plate



**SP203-D-KT**  
SP203-D-Keyboard &  
Laptop Tray



**SP204-KT**  
SP204-Keyboard &  
Laptop Tray



**PC801-KT**  
PC801-Keyboard &  
Laptop Tray



**PC702-LH**  
PC702-Laptop Holder



**PC311-DC**  
PC311 Desk Clamp



**PC311-PG**  
PC311 Pole Grommet



**SP601-DC**  
SP601 Desk Clamp



**SP601-PG**  
SP601 Pole Grommet



**PC702-SHT**  
PC702 Screen  
Hanging Type



**PC702-WM**  
PC702 Wall Mount



**PC702-HDC**  
PC702 Heavy Desk Clamp+  
Height Adjustable Pole



**PC702-DB**  
PC702 Desktop Base



## Die Casting Aluminum Alloy Parts – Monitor Arm and Base



PC702-031



PC702-033



PC702-041



PC702-042



PC702-063



SC170001-001-R02



SC170001-058A



SP201-011



SP201-012



SP201-023



SP301-142



SP301-143

## Metal Working Parts – Bracket and Mobile Laptop Desk



CT001-003B



PC311-031-A



SP201-019



SP203-032



SP301-106



SP301-107



SP901-011



SP901-015



SP902-053



SP902-056



SP902-057



SP902-058

## Plastic Injection Parts – Knob / Arm Connection / Base Cover



SP201-034



SP301-104



IT1204-011



IT1204-012



IT1216-001



PC702-064



SP301-105

# SGS

Hardline Laboratory

## TEST REPORT

Report No. : HL20178/2023

Page : 1 of 4

Date : MAR. 06, 2023

### C.D. Great Furniture Co., Ltd

No. 526, Sec. 1, Shenlin Rd., Daya Dist., Taichung City 428, Taiwan

**The following merchandise was submitted and identified by the applicant as:**

Product Description: OL002-Rolling Desk Cart

**We have tested the submitted sample(s) as requested and the following results were obtained:**

Test Requested: Refer to ANSI/ BIFMA X5.5-2021- American National Standard for Office and Institutional Furnishings - Desk and Table Products - Tests  
 Clause 4.3 Stability under vertical load test  
 Clause 5.2 Concentrated Functional Load Test  
 Clause 6 Top Load Ease Test – Cyclic  
 Clause 7 Desk/Table Unit Drop Test  
 Clause 8 Leg Strength Test  
 Clause 15 Work Surface Vertical Adjustment Test  
 Clause 18 Durability Test for Desks and Tables with Casters

Test Method & Result: --- See following sheet(s) ---

Date of Receipt: Feb. 18, 2023

Testing period: Feb. 18, 2023 ~ Mar. 03, 2023



Signed for and on behalf of  
 SGS Taiwan Ltd.

Stan Yang  
 Team Leader



This document is issued by the Company subject to its General Conditions of Service printed overleaf, available on request or accessible at <http://www.sgs.com.tw/Terms-and-Conditions> and, for electronic format documents, subject to Terms and Conditions for Electronic Documents at <http://www.sgs.com.tw/Terms-and-Conditions>. Attention is drawn to the limitation of liability, indemnification and jurisdiction issues defined therein. Any holder of this document is advised that information contained hereon reflects the Company's findings at the time of its intervention only and within the limits of client's instruction, if any. The Company's sole responsibility is to its Client and this document does not exonerate parties to a transaction from exercising all their rights and obligations under the transaction documents. This document cannot be reproduced, except in full, without prior written approval of the Company. Any unauthorized alteration, forgery or falsification of the content or appearance of this document is unlawful and offenders may be prosecuted to the fullest extent of the law. Unless otherwise stated the results shown in this test report refer only to the sample(s) tested.

# Our Product Video QR Code

